



RANGEMASTER CRF PRO / RANGEMASTER CRF R

Instruction manual

Rangemaster Pro



FOREWORD

Dear Customer,
we wish you a great deal of enjoyment and every success with your new Leica product.

Please read this manual to familiarize yourself with the full scope of functions your product has to offer.

Please use this product only as described in this manual. Only then can safe and easy operation be guaranteed.

Your Leica Camera AG

The device uses an invisible laser beam. Please read the chapters “Safety Remarks” and “Important Information” before using the product for the first time. Knowledge of the content will prevent inadvertent damage to the product, possible injuries and other risks.

SCOPE OF DELIVERY

The standard scope of delivery* contains the following:

Leica Rangemaster CRF Pro	Leica Rangemaster CRF R
3V lithium cell (type CR2)	3V lithium cell (type CR2)
Carry strap	Carry strap
Cordura case	Cordura case
Warranty card	Warranty card
Test certificate	Test certificate
Download your free iOS or Android app from the Apple™ App-Store™ or Google™ Play Store™	-

REPLACEMENT PARTS / ACCESSORIES

Contact Leica Customer Care or your specialist Leica retailer for details on the latest replacement parts / accessory range:

<https://leica-camera.com/dealer-locator>

*The actual scope of delivery may vary depending on model.

LEGAL INFORMATION

LEGAL INFORMATION ABOUT THIS MANUAL

COPYRIGHT

All rights reserved.

All text, images and graphics are subject to copyright and other laws to protect intellectual property. They must not be copied, modified or used for any purpose including trade purposes.

TECHNICAL DATA

Product changes with regards to the product or services may have occurred after the editorial deadline. The manufacturer reserves the right to effect structural or shape changes, color deviations and changes to the scope of delivery or service, where these changes or deviations are reasonably acceptable for the customer, while taking into consideration the interests of Leica Camera AG. To that extent, Leica Camera AG reserves the right to changes and errors. The images in this manual may depict accessory, special features or other items that are not part of the standard scope of delivery or service. Some pages may contain model types and services, which are not offered in specific countries.

BRANDS AND LOGOS

The brand names and logos used in this document are protected trademarks. These brands or logos must not be used without prior approval by Leica Camera AG.

LICENSE RIGHTS

Leica Camera AG intends to provide you with innovative and informative documentation. Due to the amount of creativity that has gone into its design, we ask for your understanding that Leica Camera AG must protect its intellectual property, including patents, trademarks and copyrights, and that possession of the documentation does not infer any licensing rights of the intellectual property of Leica Camera AG.

REGULATORY INFORMATION

You will find the manufacturing date of your product on the stickers of the packaging. The date format is year/month/day.

CE MARK

The CE mark on our products documents compliance with the fundamental requirements of applicable EU guidelines.

English		
Declaration of Conformity (DoC)		
"Leica Camera AG" hereby declares that this product is in compliance with the basic requirements and other relevant provisions of Directive 2014/53/EU.		
Customers can download a copy of the original DoC for our Radio Equipment products from our DoC server: www.cert.leica-camera.com		
Please contact Leica Camera AG, Am Leitz-Park 5, 35578 Wetzlar, Germany in case of any further questions		
Depending on product (see technical data)		
Type	Frequency band (center frequency)	Maximum output (dBm E.I.R.P.)
Bluetooth® Wireless Technology	2402-2480 MHz	20



RANGEMASTER CRF PRO:

APPLIED BALLISTICS and the  are Registered in the United States Patent and Trademark Office.

TECHNICAL DATA (LASER)

Laser class	IEC/EN Class 1
Wavelength (nm)	905
Pulse duration (ns)	57
Output (mW)	PRO: 1,7 R: 1,5
Beam divergence (mrad)	PRO: Vertical 0,96, horizontal 1,21 R: Vertical 0,8, horizontal 1,8

**CLASS 1
LASER PRODUCT**

With the exception of the characteristics permitted under Variance Number IEC 60825-1 Ed. 3, effective May 8, 2019, this product complies with the performance standards for laser products under 21 CFR 1040.10 and 1040.11.

DISPOSAL OF ELECTRICAL AND ELECTRONIC EQUIPMENT

(Applies within the EU and for other European countries with active waste separation policies.)



This device contains electrical and/or electronic components which must not be disposed of in general household waste. Instead, it should be disposed of at a recycling collection point provided by your local authority.

This service is free of charge. Any standard or rechargeable batteries used in this device must be removed and disposed of separately in accordance with local regulations.

Please contact your local authorities, waste disposal collection point or the retailer, from whom you purchased the device for more information on correct waste disposal.

SAFETY REMARKS

WARNING

Non-compliance with the following points may result in serious injury or death.

LASER

- The use of any operations not described in this manual or any alterations on the device may result in hazardous radiation exposure.
- The laser device is active and emitting an invisible laser beam as long as the display in the eyepiece is active. Never point the laser focusing optics at a person or animal.
- Do not depress any of the two buttons while aiming at a human eye or while looking into the optics from the lens side.
- Never aim the laser at an eye.
- Do not aim the laser at people or animals.

GENERAL INFORMATION

- Avoid looking directly at bright light sources with your Leica Rangemaster to prevent eye injury.

CAUTION

Non-compliance with the following points may result in personal injury or damage to the device.

LASER

- Avoid touching any of the two buttons while the distance measurement function is not in use to prevent an accidental activation of the laser beam.
- Do not attempt to disassemble, reassemble or repair the Leica Rangemaster yourself. Emitting laser radiation may pose a serious health risk. The manufacturer warranty is void, once a device was disassembled, reassembled or repaired.
- Remove the battery immediately and stop using the device if the device housing is damaged or if it emits a strange sound after being dropped or behaves unexpectedly for any other reason.

GENERAL INFORMATION

- Keep the device out of the reach of small children.
- Do not use the device while walking. You might trip and fall.
- Do not combine the operation of your Leica Rangemaster with other optical components, e.g. lenses or binoculars. Using the Leica Rangemaster in conjunction with another optical device increases the danger of damaging your eyes.
- Do not attempt to disassemble or modify the device; exposing the internal electronics may cause damage, injury or electric shock.

BATTERY

- Only the battery type stated and described in this manual must be used. Any improper use of the batteries or the use of unapproved battery types may result in an explosion!
- Do not expose the batteries to direct sunlight, heat, humidity or moisture for prolonged periods of time. They must not be placed in a microwave oven or a high-pressure container as this would pose a fire or explosion hazard!
- Never dispose of batteries in fire and never attempt to heat, re-charge, dismantle or break open a battery.
- Batteries must always be stored out of the reach of children. Do not leave batteries lying around, as they could be swallowed by children or pets.

CARRY STRAP

- Carry straps are usually made of very robust material. You should therefore keep it out of the reach of children. A carry strap is not a toy and poses a strangulation risk.
- Use the carry strap only for its intended purpose on a camera or on binoculars. Any other use poses the risk of injury and may possibly result in damage to the carry strap and is therefore not permitted.
- Carry straps should also not be used for cameras/binoculars during sports activities that pose a risk of entanglement (e.g. when mountain climbing and similar outdoor activities).

IMPORTANT INFORMATION

GENERAL INFORMATION

- Do not attempt to take the device apart yourself. Repairs must only be carried out by authorized workshops.
- Remove the battery from the housing if you will not be using the product for an extended period of time.
- Low temperatures impair battery performance. Carry the device close to the body in cold conditions and use a fresh battery.
- Make sure to store the batteries in a cool, dry place.
- Depleted batteries must never be disposed of in household waste as they contain toxic materials that are harmful to the environment. Battery collection points are provided at most large retail outlets; alternatively, you can dispose of old batteries at a local special waste collection point to ensure correct recycling.
- Do not touch the glass surfaces with your fingers, especially if you have previously applied hand cream, insect repellent, etc. These substances may contain chemicals that damage or destroy the coatings on the glass surfaces.
- Make a note of the serial number of your device, as this information will be extremely important in case of loss.

EYEPIECE

- An eyepiece can have the effect of a magnifying glass when exposed to direct frontal sunlight. The device must therefore be protected against extended exposure to direct sunlight. Storing the device in the shade or ideally in its case will help prevent damage to the device interior.

MEASURING VALUES

- The influence of all ballistically relevant influencing factors is greatly increased at longer ranges and considerable variations may occur. The ballistic values displayed should therefore only be viewed as a guideline.
- Regardless of whether this information is used, you are responsible for assessing the relevant hunting situation.
- Leica Camera AG does not accept liability for the accuracy of values transmitted from third-party devices.
- Powerful electric fields, e.g. emanating from radar systems, may cause errors and/or faulty values.
- The geomagnetic field can similarly cause value deviations.

Definition of the various categories of information found in this manual

Note

- Additional information

Caution

- Non-compliance may result in damage to the device and accessories
- Non-compliance may result in personal injury

Warning

- Non-compliance may result in serious injury or death



WARRANTY

Dear Leica Customer, congratulations on the purchase of your new Leica product – you are now the proud owner of a world-class brand product.

In addition to your statutory warranty claims against your seller, we, Leica Camera AG ("LEICA"), grant you voluntary warranty services for your Leica product in accordance with the following stipulations ("Leica Warranty"). The Leica warranty therefore does not limit your statutory rights as a consumer under applicable law or your rights as a consumer against the dealer with whom you have concluded the purchase contract.

THE LEICA-GUARANTEE

You have purchased a Leica product that has been manufactured according to special quality guidelines and tested by experienced specialists during the various stages of production. We provide the following Leica Warranty, valid as of April 1, 2023, for this Leica product and including the accessory parts in the original packaging. Please note that we do not offer any warranty for commercial use.

We offer an extended warranty for some Leica products, provided you register for a Leica account. Please visit www.leica-camera.com for more details.

SCOPE OF THE LEICA-GUARANTEE

During the warranty period, complaints based on manufacturing and material defects will be remedied free of charge, at LEICA's discretion, by way of repair, replacement of defective parts, or exchange for a similar Leica product in perfect condition. Replaced parts or products become the property of LEICA.

Further claims of any kind and on any legal grounds whatsoever in connection with this Leica Warranty are excluded.

EXCLUDED FROM THE LEICA WARRANTY

Parts subject to wear and tear (e.g. eyecups, leather coverings, carry straps, armoring, batteries), and parts under mechanical stress are excluded from the Leica Warranty, unless the defect was caused by manufacturing or material defects. That also applies to any exterior damage.

LAPSE OF CLAIMS UNDER THE LEICA-GUARANTEE

Claims under the warranty are void if the defect in question is due to improper handling; they may also be void if e.g. third-party accessories have been used, the Leica product has not been opened professionally or has not been repaired professionally. Claims for warranty services shall similarly be void if the serial number is unrecognizable.

ASSERTION OF THE LEICA-GUARANTEE

We require a copy of the proof of purchase of your Leica product from a LEICA-authorized dealer ("Authorized Leica Dealer") before we can accept any claim under the warranty. The purchase receipt must show the date of purchase, the Leica product with its article number and serial number, and details about the Authorized Leica Dealer. We reserve the right to request the original receipt. Alternatively, you may send us a copy of the warranty card; please note that the Warranty Card must be filled out correctly, and the product must have been purchased from an Authorized Leica Dealer.

Please send your Leica product with a copy of your purchase receipt or the Warranty Card alongside a description of the issue:

Leica Camera AG, Customer Care, Am Leitz-Park 5, 35578 Wetzlar, Germany
Email: customer.care@leica-camera.com, phone: +49(0)6441 2080-189

Leica Product Sport Lenses	Warranty Term Lenses/Mechanics	Warranty Term Electronics
Monocular Rangefinders	3 years	3 years

PICK-UP SERVICE FOR REPAIR SUBMISSIONS

(Applies for EU only)

We will organize the shipping of your device to our Customer Care department if you should notice a problem with your device during the warranty period. Please contact our service hotline to make the necessary arrangements (+49 (0)6441 2080 189). Our pick-up service will collect your Leica product at the agreed time from your premises free of charge and transport it to our Customer Care location for evaluation.

Contact: <https://leica-camera.com/contact>

TABLE OF CONTENTS

FOREWORD.....	2
SCOPE OF DELIVERY	2
REPLACEMENT PARTS / ACCESSORIES	2
LEGAL INFORMATION.....	3
SAFETY REMARKS	5
WARNING	5
CAUTION	5
IMPORTANT INFORMATION.....	6
WARRANTY.....	8
TABLE OF CONTENTS	9
PART DESIGNATIONS	10
PREPARATION	11
ATTACHING THE CARRY STRAP.....	11
INSERTING/CHANGING THE BATTERY	11
SETTING THE EYECUPS	12
DIOPTER SETTINGS.....	12
SETTINGS AND OPERATION RANGEMASTER PRO	13
ACTIVATING THE RANGEFINDER.....	13
MENU CONTROL.....	13
SETTING THE OPERATING MODE.....	15
SETTING THE DISPLAY BRIGHTNESS	15
BLUETOOTH® ACTIVATION/DEACTIVATION	16
MESSBETRIEB RANGEMASTER PRO.....	17
DISTANCE MEASUREMENT MADE EASY	17
SCAN MODE (OBJECT TRACKING).....	17

MEASURING RANGE / ACCURACY	18
DISPLAYING ATMOSPHERIC CONDITIONS	19
RANGEMASTER PRO BALLISTICS	20
EQUIVALENT HORIZONTAL RANGE (EHr).....	20
ACTUAL DISTANCE (LOS).....	20
BALLISTIC CURVE (bRLL).....	20
USING USER-DEFINED BALLISTICS CURVES.....	21
WIND CORRECTION.....	21
COMPASS CALIBRATION	22
AUTO POWER OFF.....	24
CONNECTING TO EXTERNAL METERING DEVICES.....	24
DISPLAYING THE CORRECTION VALUES.....	25
LEICA BALLISTICS APP	25
CONNECTION.....	26
REMOTE CONTROL.....	26
FIRMWARE UPDATES	26
SETTINGS AND OPERATION RANGEMASTER R	27
ACTIVATING THE RANGEFINDER.....	27
MENU CONTROL.....	27
MESSBETRIEB RANGEMASTER R.....	30
DISTANCE MEASUREMENT MADE EASY	30
SCAN MODE (OBJECT TRACKING).....	30
MEASURING RANGE / ACCURACY	31
EQUIVALENT HORIZONTAL RANGE (EHr).....	31
CARE/CLEANING	32
TECHNICAL DATA	33
LEICA CUSTOMER CARE.....	34

PART DESIGNATIONS

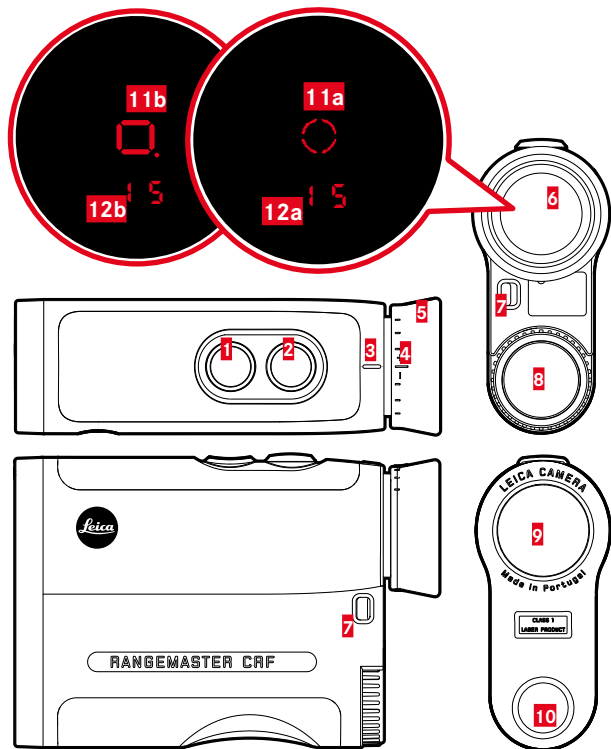
**1 Menu Selection Button**

PRO: EU, US (meter/yard display), MODE (display mode), bt (Bluetooth®), brtn (display brightness), CAL (compass calibration), ROFF (continuous Bluetooth operation)

R: EU, US (meter/yard display), EMr (equivalent horizontal range)

2 Main button

Switching the device ON/OFF

3 Index for diopter setting**4 Diopter scale****5 Eyecup****6 Eyepiece****7 Strap lugs****8 Battery compartment**

3V lithium cell (type CR2)

9 Lens**10 Laser transmission lens****11 Target mark**

a PRO: ○

b R: □

12 Display

PRO: 0 0 (value)/ bAtL (menu item)/M, Y (unit of measure)/
 * (Bluetooth®)/ \angle (inclination)

b R: 0 0 (value)

PREPARATION

ATTACHING THE CARRY STRAP

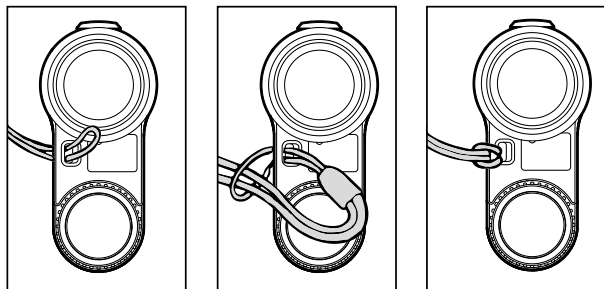

- ▶ Thread the small loop of the carry strap through the strap lug
- ▶ Thread the strap through the small loop
- ▶ Pull tight
 - The loop created should lie tightly around the strap lug.

Caution

- Check the correct attachment of the carry strap by pulling at it with some force. The length of the carry strap must not change.

INSERTING/CHANGING THE BATTERY

A cylindrical 3V lithium cell (type CR2) is required for power supply.

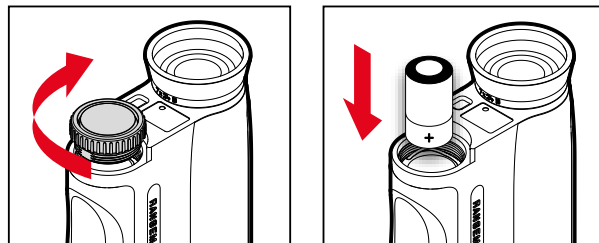

- ▶ Turn the lid over the battery compartment in anti-clockwise direction
- ▶ Remove the lid
- ▶ Insert the battery with the plus contact first
- ▶ Attach the lid
- ▶ Tighten the lid by turning it in clock-wise direction

BATTERY CHARGE LEVEL

The measured value and reticule display will flash when the battery nears depletion. You will still have enough power for another 50 measurements – but with a gradually reducing range – once the display begins flashing.



SETTING THE EYECUPS

The position of the eyecups will depend on whether you wear eye-glasses or not. Contact lens wearers can make the settings just like anyone not wearing any eyeglasses.

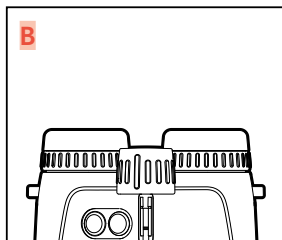
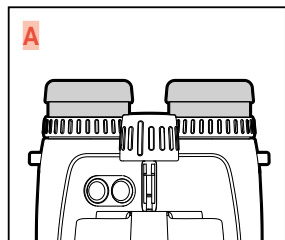

FOR USE WITHOUT EYE GLASSES

- ▶ Fold eyecup out (Fig. A)

FOR USE WITH EYE GLASSES

- ▶ Fold eyecup down (Fig. B)

DIOPTER SETTINGS

A diopter compensation function for up to ± 3.5 diopter is available to allow wearers of glasses the use of this product without eye glasses.

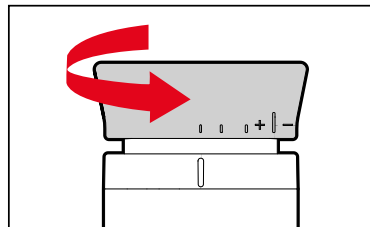

Diopter compensation allows you to adjust the sharpness of the reticule to a value that is best for your vision.

- ▶ Start device
 - The reticule appears.
- ▶ Aim at a distant object
- ▶ Turn the eyecup until the target mark is in sharp focus
 - Check the set value on the diopter scale.

Caution

Never look directly at the sun or other bright sources of light through your Leica optics! Doing so may seriously damage your eyes.

SETTINGS AND OPERATION

RANGEMASTER CRF PRO

(Rangemaster CRF R: see from page 27)

ACTIVATING THE RANGEFINDER

- ▶ Press the main button
 - The device switches on and the target mark appears.

Notes

- The device will switch off automatically after 10 s if the Bluetooth function is deactivated.
- The device will switch off after the time specified for **ROFF** if the Bluetooth function is activated.

MENU CONTROL

ACCESSING THE MAIN MENU

- ▶ Press and hold the menu selection button  (≥3 s)
 - **EU.US** appears.

NAVIGATING IN THE MAIN MENU

- ▶ Press the menu selection button repeatedly (<2 s each time) until the desired menu item appears

Menu item	Options	Description
EU.US	US	Yard display
	EU	Meter display
	CUSt	Custom settings via app
MODE	EMr	Equivalent horizontal distance
	LOS	Actual distance
	bALL	Ballistic curve
bt	OFF	Bluetooth® reception deactivated
	On	Bluetooth® reception activated
brtn	1-5	Display brightness in 5 levels
CAL		Manual compass calibration
ROFF	1 / 3 / 5	Automatic power off after 1/3/5 min





SELECTING SETTINGS

- ▶ Press the main button **2** repeatedly (<2 s each time) until the desired menu item appears
 - The selected setting is initially lit continuously as confirmation, then the display switches to the next menu item and then disappears if no further settings are made.
 - The device will switch back to metering operation after the last menu item.

MENU OVERVIEW

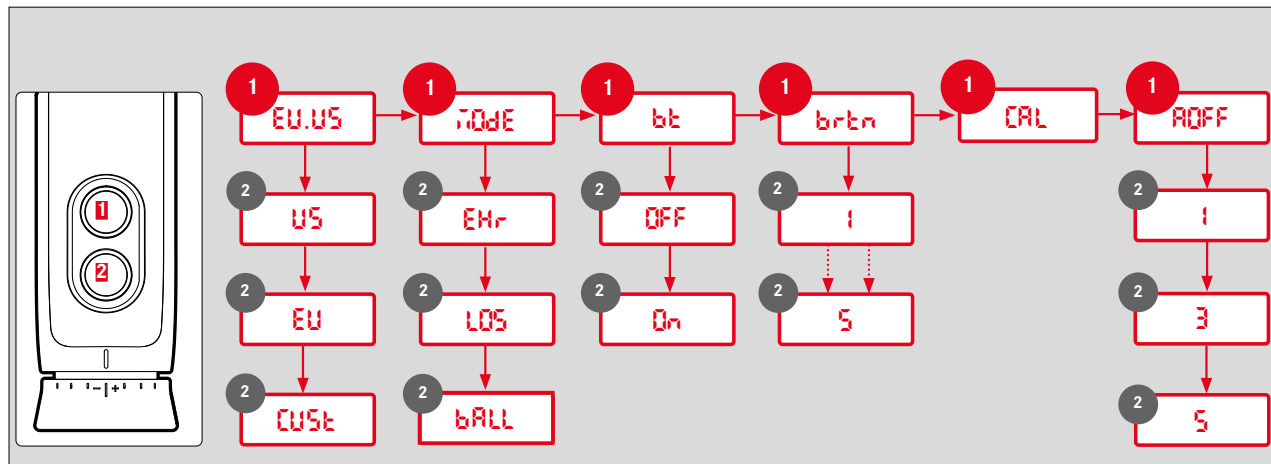

Subject to changes in design and model features.

SETTING THE UNIT OF MEASURE

The device can be set to imperial units of measure (**US**) or metric units of measure (**EU**), i.e. yards & inches/Fahrenheit/InHG (inches of mercury) for Distance/Temperature/Air Pressure, or meter & centimeter/Celsius/millibar.

- ▶ Press and hold the menu selection button
 - **EU.US** appears.
- ▶ Press the main button several times briefly until the desired setting appears

EU	Display in meters
US	Display in yards
CUSt	Settings via app

Notes

- The current setting is always visible in the display: In addition to the numbers, you will see **m** (for meters) or **y** (for yards).
- The settings will be applied from the app, provided **CUSt** is selected. Download the Leica Ballistics app from the Apple App Store™ or the Google Play Store™ to your smartphone and pair your device.

SETTING THE OPERATING MODE

The device can be used in various operating modes. See p. 20 for more information.

- ▶ Press and hold the menu selection button
- ▶ Press the menu selection button 1x briefly
 - **MODE** appears.
- ▶ Press the main button several times briefly until the desired setting appears

EHr	Equivalent horizontal distance
LDS	Actual distance
bALL	Ballistic curve

SETTING THE DISPLAY BRIGHTNESS

The display brightness can be set manually to various levels.

- ▶ Press and hold the menu selection button
- ▶ Press the menu selection button 3x briefly
 - **brtn** appears.
- ▶ Press the main button several times briefly until the desired setting appears
 - **br1 - br5** = fixed brightness values



BLUETOOTH® ACTIVATION/DEACTIVATION

The device can be connected to external devices via Bluetooth®. This will allow the use of user-defined ballistic curves from the Leica Ballistics app on a mobile device (see p. 20 and 25), or the display of ballistic correction values from external ballistic devices (see p. 22).

- ▶ Press and hold the menu selection button
- ▶ Press the menu selection button 2x briefly
 - **bt** appears.
- ▶ Press the main button several times briefly until the desired setting appears
 - **OFF**: Bluetooth® is deactivated
 - **On**: Bluetooth® is activated
 - ***** will appear, once the function is activated.

MESSBETRIEB RANGEMASTER PRO

DISTANCE MEASUREMENT MADE EASY

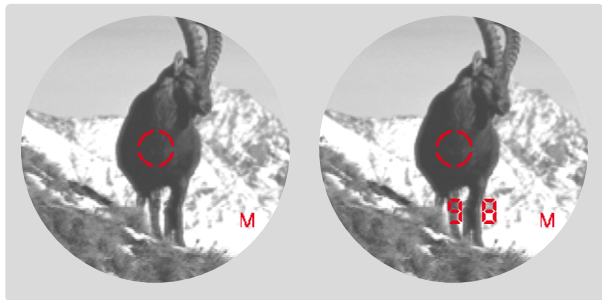

- ▶ Press the main button briefly
- ▶ Aim the target mark at the object
- ▶ Press the main button again
 - The target mark disappears briefly and the measured value is displayed.
 - Pressing the main button at any time while the target mark is lit will start a new measurement.

-- -- will appear in the following scenarios:

- Distance to the object is less than 10 meters
- Range capability is exceeded
- Object is not sufficiently reflective

SCAN MODE (OBJECT TRACKING)



- ▶ Press the main button briefly
- ▶ Aim at the object while target mark is lit
- ▶ Press and hold the main button for approx. 2.5 seconds
 - The device switches to scan mode and will then measure continuously. Scan mode is indicated by a change in the display. A new measured value appears after approx. 0.5 seconds.

Notes

- In scan mode, the **Rbc** compensation value (see p. <?>) appears only after the last measurement.
- Power consumption is much higher in scan mode than for single measurements.



MEASURING RANGE / ACCURACY

Maximum range is achieved in the following scenarios.

- Highly reflective target objects
- at a visual range of about 10 km

Long ranges can be reliably measured or achieved by holding the rangefinder very steady and/or placing it on a solid surface.

Maximum ranges are:

- on highly reflective targets = approx. 2600 m
- Trees = approx. 1500 m
- Game = approx. 500 m

The measuring range is influenced by the following factors:

Range	higher	lower
Color	white	black
Angle to lens	perpendicular	acute
Object size	large	small
Sunlight	low light (cloudy)	high light (midday sun)
Atmospheric conditions	clear	hazy
Object structure	homogeneous (house wall)	inhomogeneous (underbrush, tree)

The following range/accuracy applies in sunlight and with good visibility:

Range (in meters)	Accuracy (1 σ) Normal Operation	Accuracy (1 σ) Scan mode
10-200	$\pm 0,5$ m	$\pm 1,5$ m
200-1000	± 1 m	± 3 m
Above 1000	0.5%	0.5%

Note

- Distances below 200 m are displayed with an accuracy of one decimal place, e.g. ~~84.5~~.

DISPLAYING ATMOSPHERIC CONDITIONS

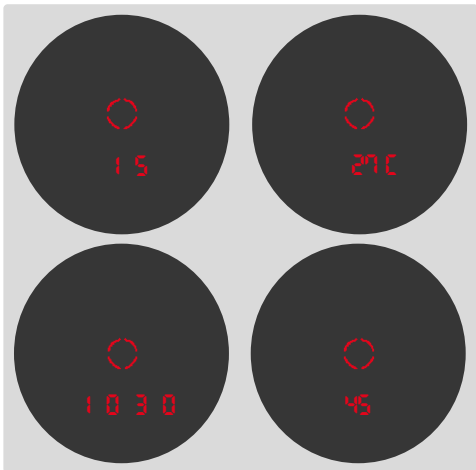

The device determines four crucial pieces of additional information during range measurement to accurately calculate the point of impact:

- The inclination of the device
- Temperature
- Atmospheric pressure
- Compass direction

These values can be displayed at any time:

- ▶ Press the main button briefly
- ▶ Press the menu selection button 2x briefly
 - The reticule appears. Then the inclination angle, the temperature and atmospheric pressure are displayed in quick succession for around 2 seconds each.

Note

- If the housing of the device initially has a significantly different temperature than the surroundings, for example when moving from inside to outside, it can take up to 30 minutes before the internal sensor can display the correct ambient temperature again.





RANGEMASTER PRO BALLISTICS

The device can be used in various operating modes.

EQUIVALENT HORIZONTAL RANGE (EH_r)

Shots at higher or lower elevation targets are subject to changed ballistic conditions. They require knowledge of the equivalent horizontal range, which is relevant for hunting. Knowledge of the equivalent horizontal range is important, for example when using ballistic reticles. EH_r values are indicated by the additional EH_r display.

- ▶ Press and hold the menu selection button
- ▶ Press the menu selection button 1x briefly
 - **EH_r** appears.
- ▶ Press the main button several times briefly until EH_r appears

Note

- This mode is preset ex works.

ACTUAL DISTANCE (L₀₅)

Only the actually measured, linear distance will be displayed (individual measurement or scan mode).

- ▶ Press and hold the menu selection button
- ▶ Press the menu selection button 1x briefly
 - **L₀₅** appears.
- ▶ Press the main button several times briefly until L₀₅ appears

BALLISTIC CURVE (b_{ALL})

The device comes equipped with a ballistic calculator, and can display correction values in addition to the measured distance.

If a ballistic profile is activated, after each distance measurement the linear, direct distance to the target is displayed twice in succession, first for 1 s, and then for 2 s each the calculated correction values for elevation and lateral.

- ▶ Press and hold the menu selection button
- ▶ Press the menu selection button 1x briefly
 - **b_{ALL}** appears.
- ▶ Press the main button several times briefly until b_{ALL} appears

Warning

- A general ballistics profile (based on .308" 175 g Sierra Match-King) is used by default ex works, which may not match the actual munition used.
- The profile most recently synched from the Leica Ballistics app to the device will be used for all subsequent accesses of the b_{ALL} function, until a new one is set. That also applies if there is no connection to the app. Make sure to always only use the profile matching the actual munition to be used.



USING USER-DEFINED BALLISTICS CURVES

A ballistic profile from the Leica Ballistics app must be created and activated on the device to determine ballistic correction values.

IN THE RANGEFINDER

- ▶ Press and hold the menu selection button
- ▶ Press the menu selection button 2x briefly
 - **bt** appears.
- ▶ Press the main button 2x briefly
 - **BT** appears.
 - Bluetooth® is activated and a connection is established (**✱** appears).

ON THE MOBILE DEVICE

- ▶ Activate Bluetooth®
- ▶ Installation and startup of the “Leica Ballistics” app
- ▶ Select the relevant device
- ▶ Create a ballistics profile under “Ballistic Profile”
- ▶ Activate a suitable ballistics profile
 - The profile will be automatically synched with the Leica device after activation.

WIND CORRECTION

Wind speed and direction can be entered on the device manual to display lateral correction values.

WIND SPEED

Wind speed settings between 0 and 40 are available. The value is entered in accordance with the current settings in km/h (**EU**) or mph (**EU**).

- ▶ Press the menu selection button briefly
 - **SPd** appears.
 - ▶ Press the main button several times briefly until the desired setting appears
- or
- ▶ Press and hold the main button
 - The device will quickly cycle through the available settings.

WIND DIRECTION

- ▶ Press the menu selection button briefly
 - **SPd** appears.
- ▶ Press the menu selection button again briefly
 - **dLr** appears.
- ▶ Press the main button several times briefly until the desired setting appears
 - **1-12**: the wind direction value is set in accordance with the clock face

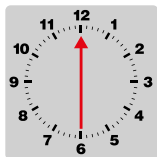

Example: wind comes from 6 o'clock.

Note

- Lateral correction values are not displayed if wind speed is set to **0**.

COMPASS CALIBRATION

Some device functions (e.g. Leica Pro Track) require directional data. That is why the device comes equipped with a digital compass, which functions like a traditional magnetic compass. The compass has a basic calibration ex works, but may need regular manual calibration (e.g. after a change in location, temperature fluctuations, in case of error readings, or a change of battery) to ensure fault-free operation. The calibration is to be done in an open, unencumbered area.

Note

- This menu item is available for selection on the device only if the option **on** is selected under the menu item **bt**. See section "BLUETOOTH® ACTIVATION/DEACTIVATION".

USING THE LEICA BALLISTICS APP:

- ▶ Establish a connection with the Leica Ballistics app
- ▶ Select **Device Settings**
- ▶ Select **Compass Calibration**
- ▶ Follow the in-app instructions

WITHOUT USING THE LEICA BALLISTICS APP:

Step 1:

- ▶ Press and hold the menu selection button
- ▶ Press the menu selection button 4x briefly
 - CAL appears
- ▶ Press the main button briefly
 - The target mark appears and begins to rotate.

Step 2:

You can now start the calibration process.

- ▶ Rotate the entire device **2x** around it own axis within 10 seconds.

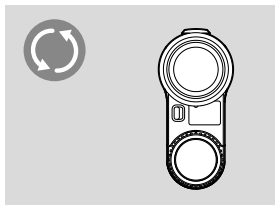

- ▶ Rotate the entire device **2x** around it own axis within 10 seconds.

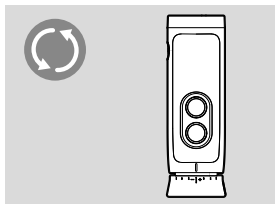

- The target mark appears and begins to rotate
 - calibration successful: **done** is displayed
 - calibration unsuccessful: **FAIL** is displayed. Repeat the calibration process.

Attention

- Metallic objects, magnetic fields, and other electronic devices in the vicinity may impact on the compass function and result in error readings. Non-magnetic metals and alloys have no impact on the compass function.
- The calibration process can be repeated at any time. The device must be switched on and the menu item must be activated to allow calibration.
- Die Kalibrierung kann jederzeit durch Drücken der Menüwahltaste abgebrochen werden. In diesem Fall wird die Kalibrierung nicht gespeichert.
- Während der Nutzung einzelner Gerätefunktionen (bspw. Leica Pro Track) ist darauf zu achten, dass die Zielmarke auf dem Ziel bleibt, bis die tatsächliche Entfernung angezeigt wird um eine einwandfreie Funktion zu gewährleisten.





AUTO POWER OFF

AUTO POWER OFF switches the device off automatically after a specific time of inactivity.

- ▶ Press and hold the menu selection button
- ▶ Press the menu selection button 5x briefly
 - **AOFF** appears.
- ▶ Press the main button several times briefly until the desired display duration appears
 - **1 / 3 / 5** minutes

Note

- This menu item is available for selection on the device only if the option **On** is selected under the menu item **b.t.**. See section "BLUETOOTH® ACTIVATION/DEACTIVATION".

CONNECTING TO EXTERNAL METERING DEVICES

External devices from manufacturers like Nielsen-Kellermann (Kestrel® models) or Garmin® (Foretrex® GPS) are compatible for providing ballistic correction values. These devices receive data like the measured distance, angle and target direction. The devices include the data in the calculation of ballistic values, and return the relevant correction values.

- ▶ External device configuration
- ▶ Press and hold the menu selection button
- ▶ Press the menu selection button 2x briefly
 - **b.t.** appears.
- ▶ Press the main button 2x briefly
 - **On** appears.
 - Bluetooth® is activated and a connection is established (**✱** appears).

Notes

- The device can only be connected to one smartphone or other external device at a time. An existing connection must therefore be actively disconnected (deactivate Bluetooth®).
- Take note of the range capabilities of the external devices used.
- Read the manual of the relevant external device for operating instructions.

DISPLAYING THE CORRECTION VALUES

The display of ballistic correction values includes the following:

⬆ (up)	Upward correction
⬇ (down)	Downward correction
⬅ (left)	Correction to the left
➡ (right)	Correction to the right

The following values are included in the calculation of correction values.

- Measured distance to the target
- Inclination angle of the device
- Measured temperature and atmospheric values
- Set wind speed and wind direction

LEICA BALLISTICS APP

The device can be remotely controlled via smartphone. The Leica Ballistics app allows the setting and storing of personal ballistics profiles. That will require the installation of the “Leica Ballistics” app on the mobile device. A list of available functions and instructions for their use can be found in the app.

<http://www.leica-ballistics.com>





CONNECTION

ESTABLISHING A CONNECTION

IN THE RANGEFINDER

- ▶ Press and hold the menu selection button
- ▶ Press the menu selection button 2x briefly
 - **bE** appears.
- ▶ Press the main button 2x briefly
 - **On** appears.
 - Bluetooth® is activated and a connection is established (**✖** appears).

ON THE MOBILE DEVICE

- ▶ Activate Bluetooth®
- ▶ Launch the Leica Ballistics app
- ▶ Select the relevant device

DISCONNECTION

- ▶ Press and hold the menu selection button
- ▶ Press the menu selection button 2x briefly
 - **bE** appears.
- ▶ Press the main button 1x briefly
 - **OFF** appears.
 - Bluetooth® is deactivated and the connection is dropped.

REMOTE CONTROL

All functions and settings of the device can be done via a mobile device.

- ▶ Establishing a connection
- ▶ Operate the desired functions via the app

FIRMWARE UPDATES

Leica is continuously working on the further improvement and optimization of their products. Some of these improvements and expansions of the functional scope can be installed at a later time. Leica releases so-called firmware updates at irregular intervals. These updates are handled via the Leica Ballistics app.

The information contained in this manual references the most current firmware version at the time of market launch.

- ▶ Establishing a connection
- ▶ Follow in-app instructions

Caution

- Do not switch off the device during the update process!

SETTINGS AND OPERATION

RANGEMASTER R

ACTIVATING THE RANGEFINDER

- ▶ Press the main button
 - The device switches on and the target mark appears.

MENU CONTROL

ACCESSING THE MAIN MENU

- ▶ Press and hold the menu selection button  (≥3 s)
 - **EU.US** appears.

NAVIGATING IN THE MAIN MENU

- ▶ Press the menu selection button repeatedly (<2 s each time) until the desired menu item appears

Menu item	Options	Description
EU.US	US	Yard display
	EU	Meter display
EHR	ON	Activate EHR
	OFF	Deactivate EHR





SELECTING SETTINGS

- ▶ Press the main button repeatedly (<2 s each time) until the desired menu item appears
 - The selected setting is initially lit continuously as confirmation, then the display switches to the next menu item and then disappears if no further settings are made.

MENU OVERVIEW

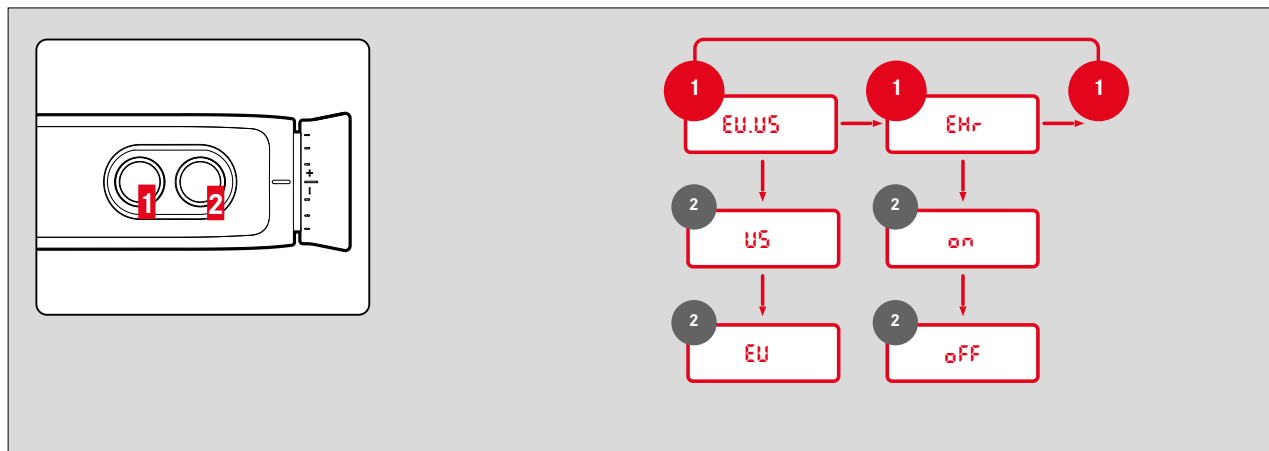

Subject to changes in design and model features.



SETTING THE UNIT OF MEASURE

The device can be set to imperial units of measure (**US**) or metric units of measure (**EU**).

- ▶ Press and hold the menu selection button
 - **EU.US** appears.
- ▶ Press the main button several times briefly until the desired setting appears

EU	Display in meters
US	Display in yards

Note

- The current setting is always visible in the display: a dot will be shown at the bottom right next to the reticule if metric values are selected.



MESSBETRIEB RANGEMASTER R

DISTANCE MEASUREMENT MADE EASY



- ▶ Press the main button briefly
- ▶ Aim the target mark at the object
- ▶ Press the main button again
 - The target mark disappears briefly and the measured value is displayed.
 - Pressing the main button at any time while the target mark is lit will start a new measurement.

-- -- will appear in the following scenarios:

- Distance to the object is less than 10 meters
- Range capability is exceeded
- Object is not sufficiently reflective

SCAN MODE (OBJECT TRACKING)



- ▶ Press the main button briefly
- ▶ Aim at the object while target mark is lit
- ▶ Press and hold the main button for approx. 2.5 seconds
 - The device switches to scan mode and will then measure continuously. Scan mode is indicated by a change in the display. A new measured value appears after approx. 0.5 seconds.

MEASURING RANGE / ACCURACY

Maximum range is achieved in the following scenarios.

- Highly reflective target objects
- at a visual range of about 10 km

Long ranges can be reliably measured or achieved by holding the rangefinder very steady and/or placing it on a solid surface.

Maximum ranges are:

- on highly reflective targets = approx. 1800 m
- Trees = approx. 1400 m
- Game = approx. 900 m

The measuring range is influenced by the following factors:

Range	higher	lower
Color	white	black
Angle to lens	perpendicular	acute
Object size	large	small
Sunlight	low light (cloudy)	high light (midday sun)
Atmospheric conditions	clear	hazy
Object structure	homogeneous (house wall)	inhomogeneous (underbrush, tree)

The following range/accuracy applies in sunlight and with good visibility:

Range (in meters)	Accuracy (1 σ) Normal Operation	Accuracy (1 σ) Scan mode
10-200	± 0.5 m	± 1.5 m
200-400	± 1 m	± 2 m
400-800	± 2 m	± 3 m
Above 800	0.5%	0.5%

EQUIVALENT HORIZONTAL RANGE (EH_r)

Shots at higher or lower elevation targets are subject to changed ballistic conditions. They require knowledge of the equivalent horizontal range, which is relevant for hunting. Knowledge of the equivalent horizontal range is important, for example when using ballistic reticles. EH_r values are indicated by the additional EH_r display.

- ▶ Press and hold the menu selection button
- ▶ Press the menu selection button 1x briefly
 - EH_r appears.
- ▶ Press the main button several times briefly until the desired setting appears
(ON, OFF)
- ▶ Press the menu selection button briefly

Note

- EH_r values are provided only between 10 m and 1100 m for safety reasons. Beyond that, only the actually measured, linear range is provided.

CARE/CLEANING

- Your Leica rangefinder requires no special care.
- Coarse dirt particles like sand can be removed with a soft brush or simply blown off.
- Do not use excessive force when cleaning a severely soiled lens surface. The coating is abrasion resistant, but not impervious to sand or salt crystals.
- Always rinse off any traces of salt water! Dried salt crystals could damage the surfaces.
- Fingerprints, etc. on front lenses and eyepiece lenses can be pre-cleaned with a damp cloth and then wiped dry with a clean leather or lint-free cloth.
- The rangefinder should be stored in a well-ventilated, dry and cool place to prevent fungal growth (particularly important in humid climates).
- Do not use alcohol or chemical cleaning solutions on the optics or housing.

TECHNICAL DATA

Designation	Leica Rangemaster CRF Pro	Leica Rangemaster CRF R
Device type	Rangefinder	Rangefinder
Type No.	4062	4032
Order No.	40547	40504
Scope of delivery	Rangefinder, carry string, carry case, lens cleaning cloth, quick start guide, certificate, 3V lithium cell (Type CR2)	Rangefinder, carry string, carry case, lens cleaning cloth, quick start guide, certificate, 3V lithium cell (Type CR2)
Magnification	7x	7x
Lens diameter	24mm	24mm
Exit pupil	3.4mm	3.4mm
Twilight factor	13	13
Relative brightness	11.8	11.8
Field of view (at 1,000 m/yds)	115.6m	115.6m
Subjective viewing angle	6.6°	6.6°
Eye relief	15mm	15mm
Prism system	Roof	Roof
Coating	On lenses: High Durable Coating (HDC™) and hydrophobic Aqua-Dura® coating on external lenses On prisms: phase correction coating P40	On lenses: High Durable Coating (HDC™) On prisms: phase correction coating P40
Diopter compensation	±3.5 dpt	±3.5 dpt
Compensation for eye glasses users	Yes, equipped with fold-down rubber eyecup	Yes, equipped with fold-down rubber eyecup
Maximum range	2500m/2800yds	1800m/2000yds
Minimum range	Approx. 10m	Approx. 10m
Measuring accuracy	10–200m: ±0.5m, 200–400m: ±1m, 400–800m: ±2m, > 800m: 0.5%	10–200m: ±0.5m, 200–400m: ±1m, 400–800m: ±2m, > 800m: 0.5%
Display/Unit of measure	4 seven-segment LEDs plus additional icons, optional display setting in yard/inch or meter/centimeter	4 seven-segment LEDs plus additional icons, optional display setting in yard/inch or meter/centimeter
Max. measurement time	Approx. 0.3s	Approx. 0.3s
Metering methods	Single measurement, scan mode	Single measurement, scan mode
Laser	Invisible, safe for eyes in compliance with EN and FDA Class 1	Invisible, safe for eyes in compliance with EN and FDA Class 1
Material	Impact resistant plastic (ABS)	Impact resistant plastic (ABS)
Interfaces	Bluetooth® 4.1	-
Waterproofing	For 30min: waterproof to 1m deep	For 30min: waterproof to 1m deep
Operating temperature	-20 to +55°C	-20 to +55°C
Storage temperature	-40 to +85°C	-40 to +85°C
Battery	3V lithium cell (type CR2)	3V lithium cell (type CR2)
Dimensions (WxHxD)	Approx. 78x35x113mm	Approx. 78x35x113mm
Weight (with battery)	Approx. 185g	Approx. 180g

Subject to changes in design, production, and scope of delivery.



LEICA CUSTOMER CARE

Please contact the Customer Care department of Leica Camera AG for the maintenance of your Leica equipment and for help and advice regarding Leica products and how to order them. You can also contact the Customer Care department or the repair service provided by your regional Leica subsidiary for repairs or warranty claims.

Leica Camera AG

Leica Customer Care
Am Leitz-Park 5
35578 Wetzlar
Germany

Phone: +49(0)6441 2080-189

Fax: +49(0)6441 2080-339

Email: customer.care@leica-camera.com

www.leica-camera.com