

Instruction Manual

omegon



Omegon® Alpheon-NV 5x40

English version 5.2015 Rev A

The Omegon® Alpheon-NV 5x40

Congratulations on the purchase of the new Omegon® Alpheon-NV 5x40. This night vision device was designed to work under low light conditions. It captures and intensifies light coming from objects. With its built in IR-Illuminator one can increase the observing range. Special light conditions, such as Moonlight allow even to increase its observing range to infinite. It features a 5x optical and 8x digital zoom.

1. Included parts.

We have included several accessories that will make the use of the device easier, please take a look at the list of the parts so you can identify them in the future.

- | | |
|-----------------------------|----------------|
| 1. Video cables; | 2. USB cable; |
| 3. Power adapter; | 4. Carry case; |
| 5. Two Batteries (RCR123A); | 6. Lens cloth. |
| 7. Hand strap; | |

2. Getting Started.

It is important to identify the main features of the device before use. There are two main feature groups as shown.

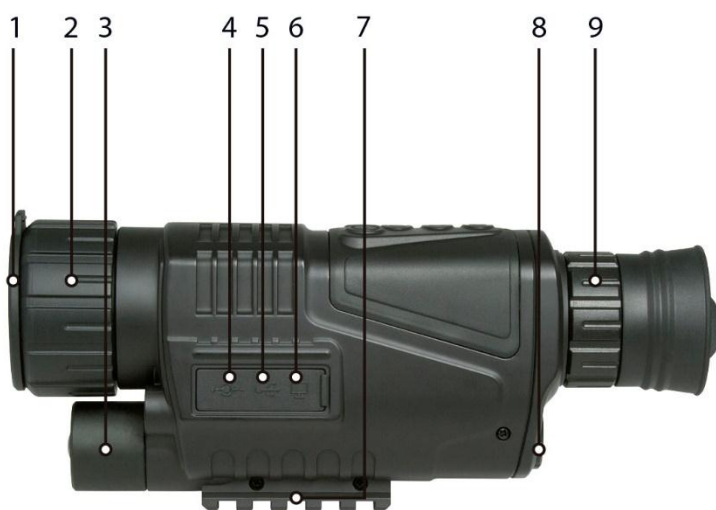

Figure 1

- | | |
|------------------------------|-------------------------------|
| 1. Objective dust cap | 2. Objective focusing barrel; |
| 3. IR-illuminator; | 4. DC IN (5volt); |
| 5. USB socket; | 6. Video Out; |
| 7. Tripod mount; | 8. Lens cloth; |
| 9. Eyepiece focusing barrel. | |



Figure 2

- | | |
|----------------------------|-------------------|
| 10. Rubber eyeguard; | 11. Dioptre mark; |
| 12. Power/selection button | 13. IR button; |
| 14. MODE button; | 15. UP button; |
| 16. DOWN button; | 17. Hand strap. |

Start by removing the battery's compartment cap. Insert a coin in the cap's slot and rotate counter-clockwise. Insert the batteries as shown. Make sure to insert it in the correct position (negative end first) – figure 3. Retighten back the cap so that the batteries do not shake.

Turn the device ON by pressing the Power/selector button for 3 seconds. Remove the dust cap. Look through the eyepiece. The LCD display should be illuminated. To power OFF press for another 3 seconds until the display turns off.



Figure 3

When the device is turned to ON the display will show some icons as shown in figure 4. Notice that every time the device is disconnected and connected the capture mode is set to Photo mode.

Main screen features (figure 4)

1. Battery charge status
2. Remaining image space
3. Capture mode
4. Record support

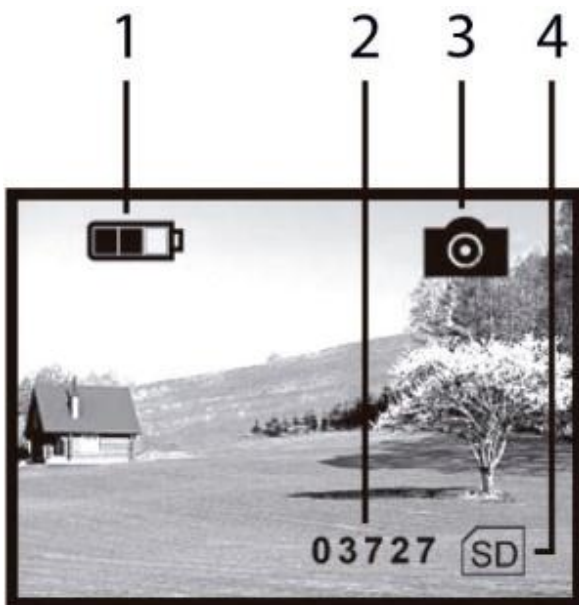

Figure 4

The supplied batteries can be recharged through the 5V DC IN socket.

Brightness adjustment (figure 5)

Brightness of the screen can be adjusted. Press the IR button (#13 – figure 1). "Bright:" will appear on the screen. Press UP and DOWN to adjust the brightness. In this example "7". There are 9 levels of brightness from 1 to 9. Press UP to increase and DOWN to decrease brightness. To exit brightness adjustment press IR button again.



Figure 5

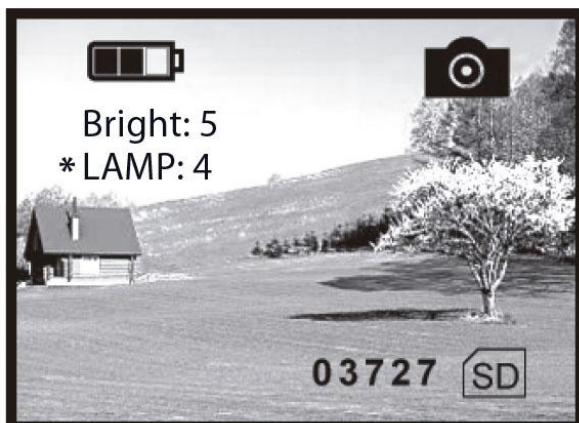

Figure 6

Infrared illumination (figure 6)

The IR illumination improves the range and the brightness of the image. To adjust IR illumination press the IR button twice (#13 – figure 1). "*LAMP:" will show on the screen. Press UP and DOWN to adjust the illumination. In this example "4". There are 9 levels of illumination from 1 to 9. Press UP to increase and DOWN to decrease illumination. To exit illumination adjustment press IR button again.

After 8 seconds, during which no changes are made the screen returns to its current mode. We recommend reducing the IR illumination to ZERO to save battery if there is enough outside light (moonlight etc...)

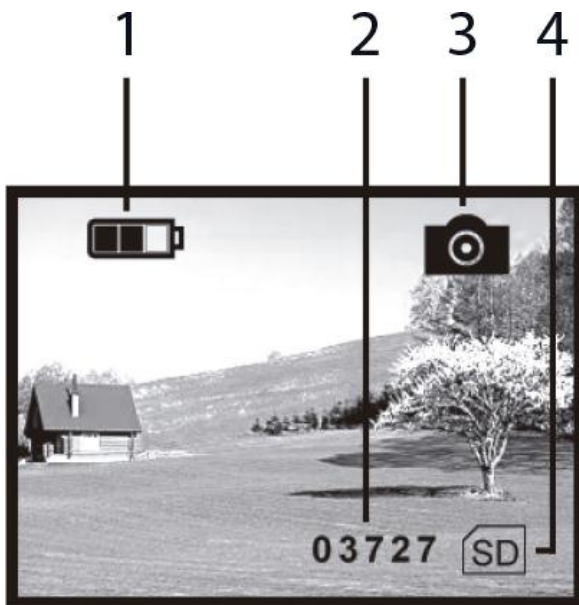

Figure 7

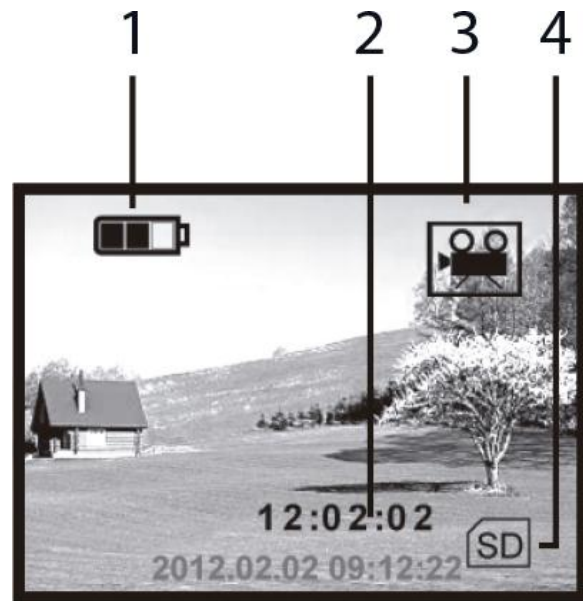

Figure 8

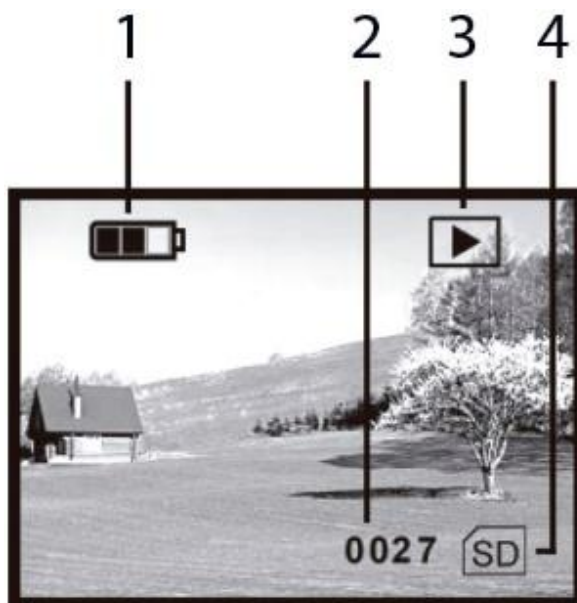

Figure 9

The device is supplied with a 4GB SD card. It is enough to record about 45minutes of video.

Photo mode (figure 7)

When the device is set to ON it goes automatically to Photo mode. If not, scroll through the available options by pressing MODE. Press SELECT to capture an image. The image will be recorded.

1. Battery charge status
2. Remaining image space
3. Photo mode
4. Record support

Video mode (figure 8)

To enter video mode press the MODE button twice to scroll through the available optics. The video logo will show up. Press SELECT to capture a video. The video will be recorded.

1. Battery charge status
2. Remaining video time
3. Video mode
4. Record support

Photo Play (figure 9)

While in photo mode press MODE button to change to Play mode. This will allow to review and play the captured images.

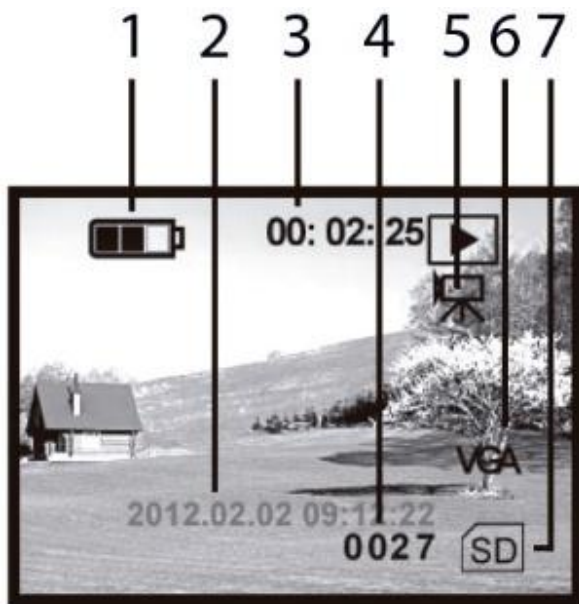

Figure 10

Video Play (figure 10)

While in video mode press MODE button to change to Play mode. This will allow to review and play the captured videos.

1. Battery charge status
2. Date/Time
3. Video recording time
4. Video serial number
5. Video play mode
6. Video VGA format
7. Record media

Date and time

To set date and time please connect the device to a computer using the supplied USB cable. Look for the device from the list of available devices. Locate the

folder that contain the time.txt and change the time accordingly. Save and close the file. Copy it to the device's root folder. Remove the USB cable from the socket.

Time format should be of this type: yyyy.mm.dd hh.mm.ss for example 2015.07.12 23:12
The date and time will be erased from the device if the batteries are removed or empty or if the device is not used for long periods of time.

Video OUT

You can connect the device to a TV or a video capture device. Simply use the supplied video cable. Connect it to the video socket. Hold the POWER button for three seconds so that the device outputs video signal.

USB connection/Computer connection

Connecting the device to a computer will allow the batteries to charge. It will also allow to copy or erase some of the captured videos or photos. Simply look for the recorded files in the SD card.

Auto power OFF

The device turns OFF if not used for 3 minutes except for play modes (Photo and Video).

Features

Batteries: 2x RCR123A (650mAh, 3.7V) – charge for at least 12 hours before first use. Connect the power cable to the DC IN 5V socket to charge the batteries. A red LED – next to the socket - will light while charging. The batteries are fully charged when the LED turns off.

The LED will not light up when charging the Batteries through the USB cable.

Weight: 420g

Magnification: 5x

Aperture lens: 40mm

FOV: 3.75 to 5 degrees

Range: low light 200m